

# Montage

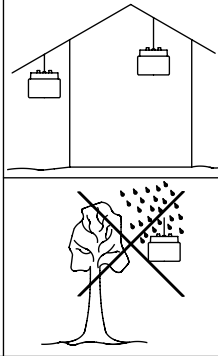

CE

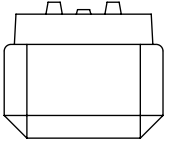
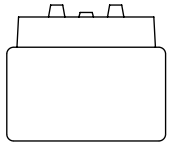

IP 54

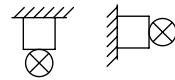

max. 25°C

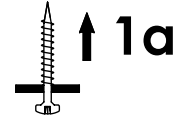
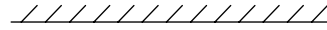
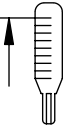

1b ↑

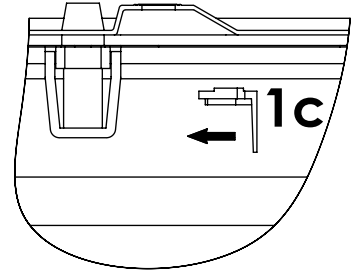

2a

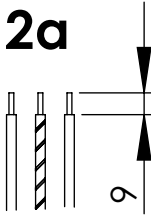

2b

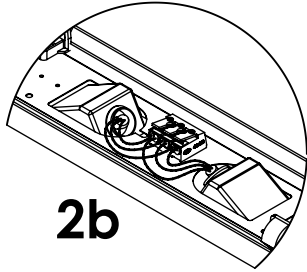

Wanne mittig aufsetzen

3c

3b

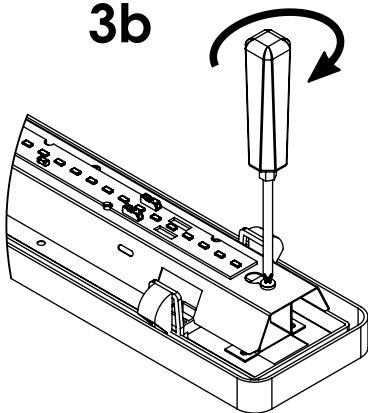

3a

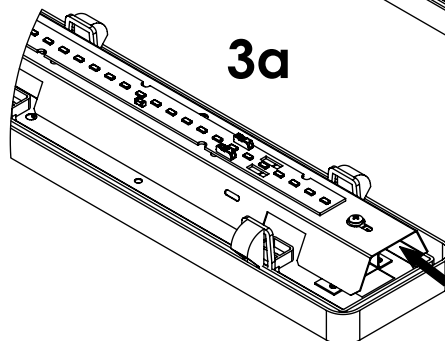

Euro-Line Wanne min. 20mm  
RWA/Europrisma Wanne min. 10mm

4

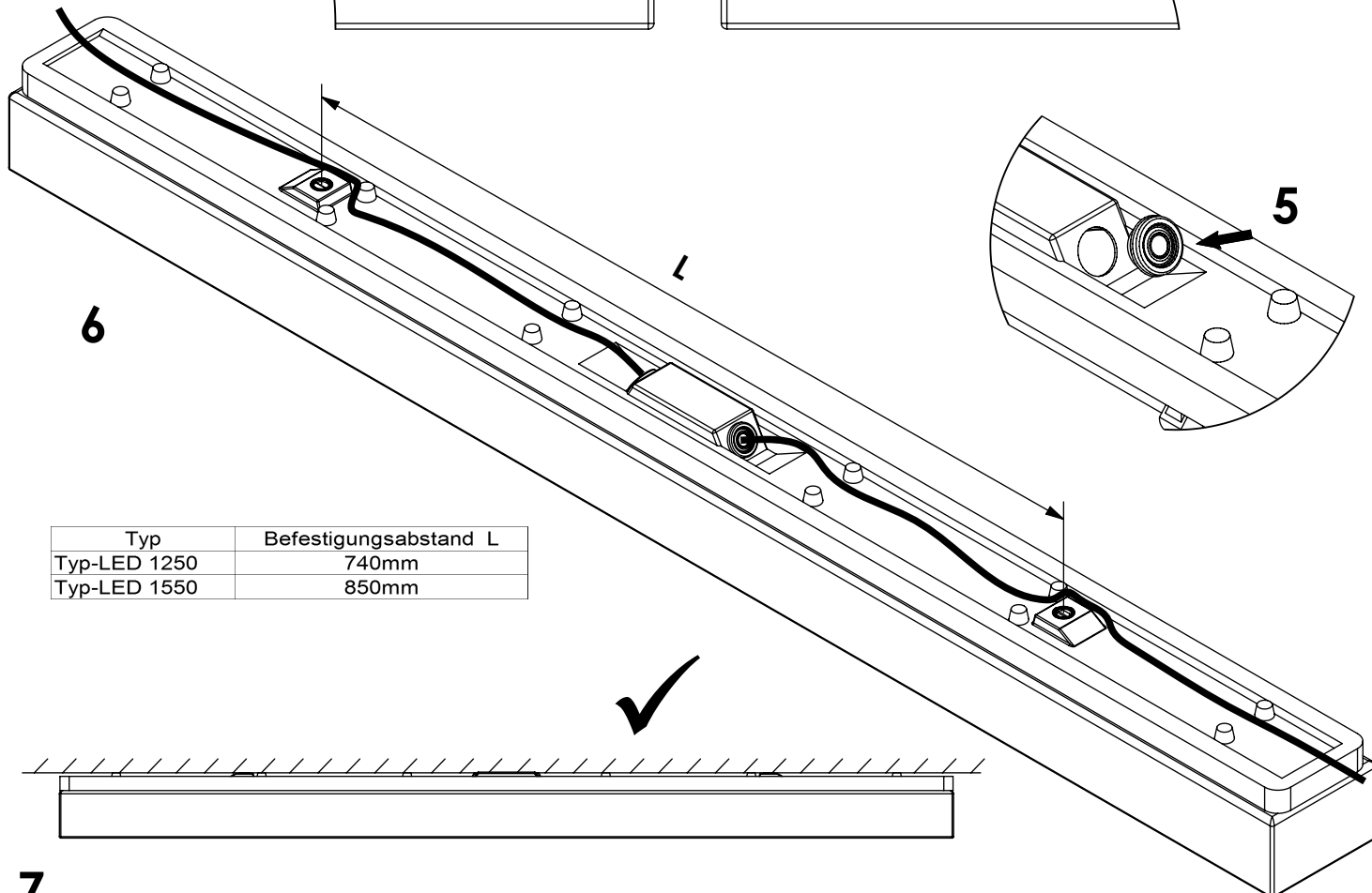
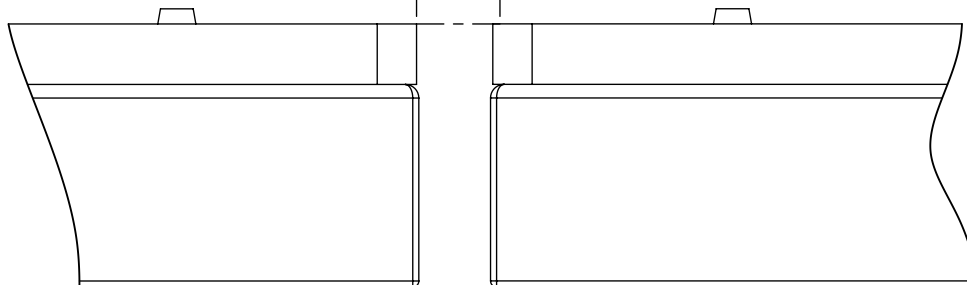

6

5

Typ	Befestigungsabstand L
Typ-LED 1250	740mm
Typ-LED 1550	850mm

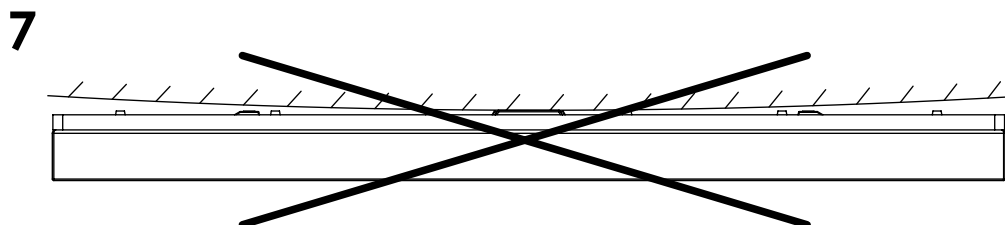
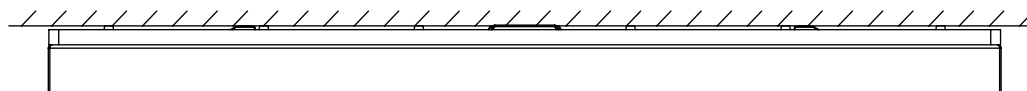

7



### Allgemeine Sicherheitshinweise General safety notes

(GB)

- Luminaires with limited surface temperatures.
- For use in environments where an accumulation of non-conductive dust on the luminaire.
- Installation/maintenance only by skilled personnel.
- During overhaul/maintenance only use original parts.
- If any luminaire is subsequently modified, the person responsible for the modification shall be considered the manufacturer.
- The manufacturer bears no liability for damage caused by inappropriate use or application.
- Due to problems with chemical resistance, choose cleaning materials which are suitable for plastic.

(F)

- Luminaires avec surfaces à températures limitées.
- Pour zones où la présence de poussières non conductrices est probable.
- Les opérations d'installation et d'entretien doivent être effectuées exclusivement par des personnes qualifiées.
- Dans le cas d'une remise en état, utiliser uniquement des composants d'origine.
- Toutes modifications apportées au luminaire se feront sous la responsabilité exclusive de celui qui les effectue.
- Le fabricant décline toute responsabilité résultant d'un mise en oeuvre inappropriée du produit.
- Respectez la résistance chimique du matériel: n'utilisez que des détergents compatibles avec les matières synthétiques.

(D)

- Leuchte mit begrenzter Oberflächentemperatur
- für Bereiche, in denen nicht leitfähige Stäube zu erwarten sind.
- Montage/Wartung nur durch Fachkräfte.
- Bei Instandsetzung/Instandhaltung nur Originalteile verwenden.
- Werden nachträglich Änderungen an Leuchten vorgenommen, so gilt derjenige als Hersteller, der diese Änderung vornimmt.
- Der Hersteller übernimmt keine Haftung für Schäden, die durch unsachgemäßen Einsatz entstehen.
- Chemische Beständigkeit beachten. Nur kunststoffverträgliche Reinigungsmittel verwenden.